











	Power	Standard  Kg	 Kg	MW/PIR  Kg	MW/PIR +  Kg
	15W	3.4	3.9	3.6	4.1
	15W	3.7	4.2	3.9	4.4
	15W	3.7	4.2	3.9	4.4



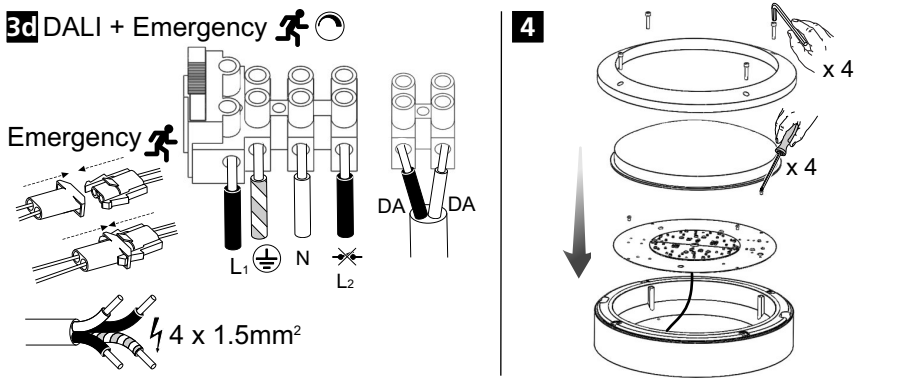
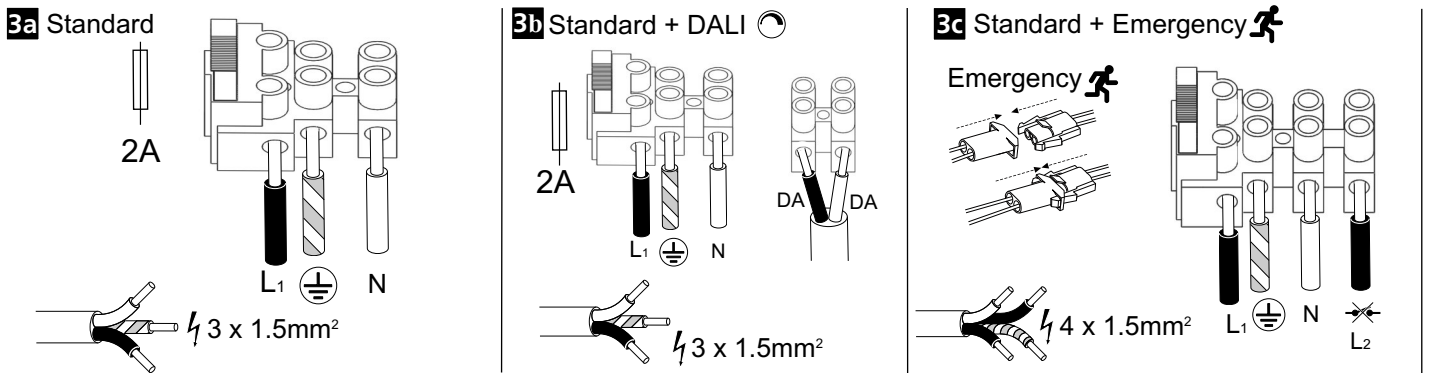
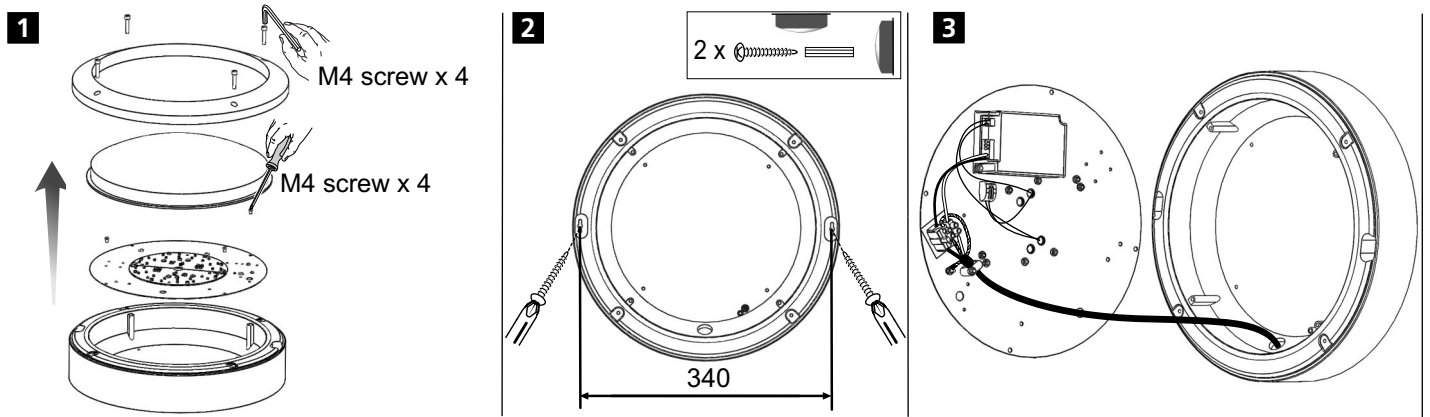
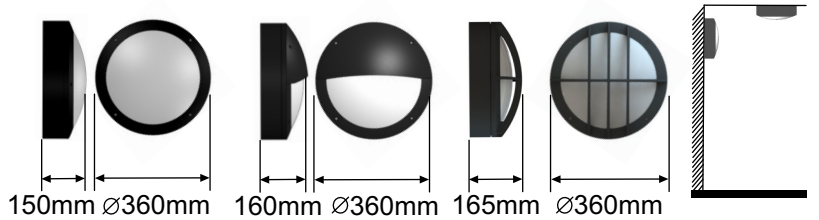

 **Operation & Maintenance**  
Failed light source should be replaced promptly or the circuit switched off to avoid possible damage to control gear.

**Important - Safety**  
Before carrying out any servicing on these luminaires, ensure that the mains supply is fully isolated.  
Disconnect the luminaire before insulation testing of the installation.

Circuit Breaker Type	C10	C16	B10	B16
Standard Luminaire	29	54	17	28
Dimmable Luminaire	76	136	45	80

 Microwave detection / PIR  
 MW / PIR Instructions

  The light source contained in this luminaire shall only be replaced by the manufacturer or his service agent or a similar qualified person.